

600V N-Channel MOSFET

GENERAL DESCRIPTION

This Power MOSFET is produced using advanced planar stripe DMOS technology. This latest technology has been especially designed to minimize on-state resistance, Have a high rugged avalanche characteristics. These devices are well suited for high efficiency switched mode power supplies, active power factor correction. electronic lamp ballasts based on half bridge topology.

V_{DSS}	$R_{DS(ON)}$	I_D
600V	2.5Ω	4A

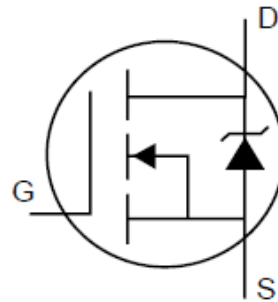
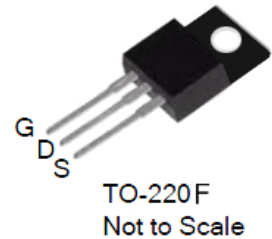
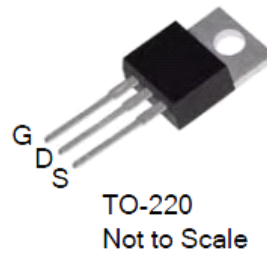

Features

- 4A, 600V, $R_{DS(on)} = 2.5\Omega$ @ $V_{GS} = 10V$
- Low gate charge (typical 16nC)
- Fast switching
- 100% avalanche tested
- Improved dv/dt capability

Ordering Information

PART NUMBER	PACKAGE	BRAND
4N60/4N60F	TO-220/220F	0GFD

Absolute Maximum Ratings

TC = 25°C unless otherwise noted

Symbol	Parameter	4N60	4N60F	Units
V _{DSS}	Drain-Source Voltage	600		V
I _D	Drain Current - Continuous (TC = 25°C) - Continuous (TC = 100°C)	4.0	4.0	A
		2.4	2.4	A
I _{DM}	Drain Current- Pulsed (Note 1)	16	16	A
V _{GSS}	Gate-Source Voltage	± 30		V
E _{AS}	Single Pulsed Avalanche Energy (Note 2)	160		mJ
E _{AR}	Repetitive Avalanche Energy (Note 1)	10		mJ
dv/dt	Peak Diode Recovery dv/dt (Note 3)	4.5		V/ns
P _D	Power Dissipation (TC = 25°C)	100	33	W
	Derate above 25°C	0.8	0.26	W/°C
T _J , T _{STG}	Operating and Storage Temperature Range	-55 to +150		°C
T _L	Maximum lead temperature for soldering purposes, 1/8" from case for 5 seconds	300		°C

Thermal Characteristics

Symbol	Parameter	4N60	4N60F	Units
R _{θJC}	Thermal Resistance, Junction-to-Case	1.25	3.79	°C/W
R _{θCS}	Thermal Resistance, Case-to-Sink Typ.	0.5	--	°C/W
R _{θJA}	Thermal Resistance, Junction-to-Ambient	62.5	62.5	°C/W

Electrical Characteristics

TC = 25°C unless otherwise noted

Symbol	Parameter	Test Conditions	Min	Typ	Max	Units
--------	-----------	-----------------	-----	-----	-----	-------

Off Characteristics

BV _{DSS}	Drain-Source Breakdown Voltage	V _{GS} = 0 V, I _D = 250 μA	600	--	--	V
ΔBV _{DSS} /ΔT _J	Breakdown Voltage Temperature Coefficient	I _D = 250 μA, Referenced to 25°C	--	0.6	--	V/°C
I _{DSS}	Zero Gate Voltage Drain Current	V _{DS} = 600 V, V _{GS} = 0 V	--	--	1	μA
		V _{DS} = 480 V, T _C = 125°C	--	--	10	μA
I _{GSSF}	Gate-Body Leakage Current, Forward	V _{GS} = 30 V, V _{DS} = 0 V	--	--	100	nA
I _{GSSR}	Gate-Body Leakage Current, Reverse	V _{GS} = -30 V, V _{DS} = 0 V	--	--	-100	nA

On Characteristics

V _{GS(th)}	Gate Threshold Voltage	V _{DS} = V _{GS} , I _D = 250 μA	2.0	--	4.5	V
R _{DS(on)}	Static Drain-Source On-Resistance	V _{GS} = 10 V, I _D = 2.0 A	--	2.0	2.5	Ω

Dynamic Characteristics

C _{iss}	Input Capacitance	V _{DS} = 25 V, V _{GS} = 0 V, f = 1.0 MHz	--	560	--	pF
C _{oss}	Output Capacitance		--	55	--	pF
C _{rss}	Reverse Transfer Capacitance		--	7	--	pF

Switching Characteristics

$t_{d(on)}$	Turn-On Delay Time	$V_{DD} = 300\text{ V}, I_D = 4\text{ A},$ $R_G = 25\ \Omega$	--	10	--	ns
t_r	Turn-On Rise Time		--	40	--	ns
$t_{d(off)}$	Turn-Off Delay Time		--	40	--	ns
t_f	Turn-Off Fall Time		(Note 4, 5)	--	50	--
Q_g	Total Gate Charge	$V_{DS} = 480\text{ V}, I_D = 4\text{ A},$ $V_{GS} = 10\text{ V}$	--	16	--	nC
Q_{gs}	Gate-Source Charge		--	2.5	--	nC
Q_{gd}	Gate-Drain Charge		(Note 4, 5)	--	6.5	--

Drain-Source Diode Characteristics and Maximum Ratings

I_S	Maximum Continuous Drain-Source Diode Forward Current		--	--	4.0	A
I_{SM}	Maximum Pulsed Drain-Source Diode Forward Current		--	--	16	A
V_{SD}	Drain-Source Diode Forward Voltage	$V_{GS} = 0\text{ V}, I_S = 4\text{ A}$	--	--	1.5	V
t_{rr}	Reverse Recovery Time	$V_{GS} = 0\text{ V}, I_S = 4\text{ A},$ $di_F / dt = 100\text{ A}/\mu\text{s}$	--	280	--	ns
Q_{rr}	Reverse Recovery Charge		(Note 4)	--	1.8	--

Notes:

1. Repetitive Rating : Pulse width limited by maximum junction temperature
2. $L = 20\text{ mH}, I_{AS} = 4\text{ A}, V_{DD} = 50\text{ V}, R_G = 25\ \Omega,$ Starting $T_J = 25^\circ\text{C}$
3. $I_{SD} \leq 4\text{ A}, di/dt \leq 200\text{ A}/\mu\text{s}, V_{DD} \leq BVDSS,$ Starting $T_J = 25^\circ\text{C}$
4. Pulse Test : Pulse width $\leq 300\ \mu\text{s},$ Duty cycle $\leq 2\%$
5. Essentially independent of operating temperature

Typical Characteristics

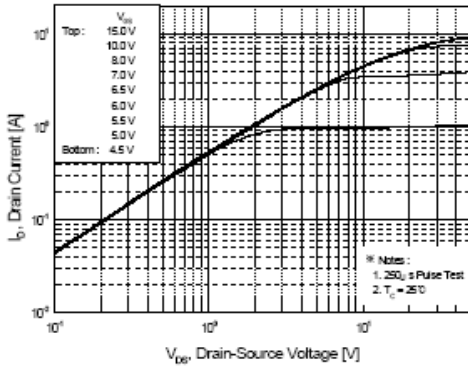

Figure 1. On-Region Characteristics

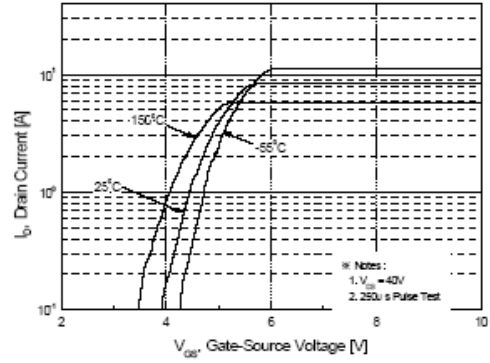

Figure 2. Transfer Characteristics

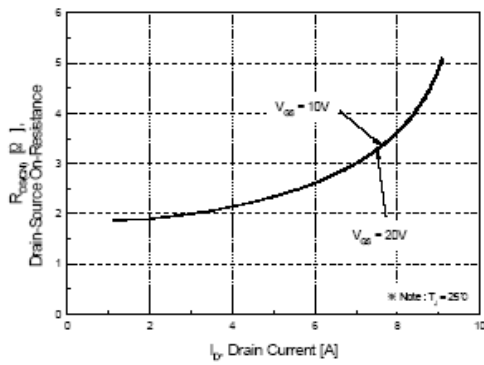

Figure 3. On-Resistance Variation vs Drain Current and Gate Voltage

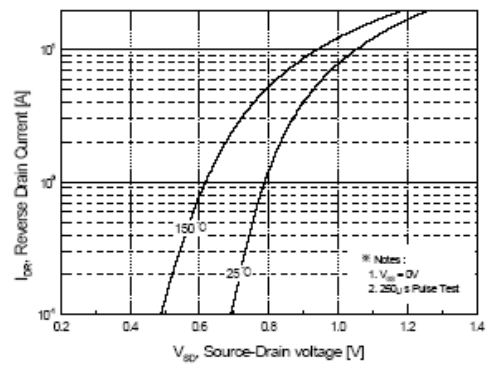

Figure 4. Body Diode Forward Voltage Variation with Source Current

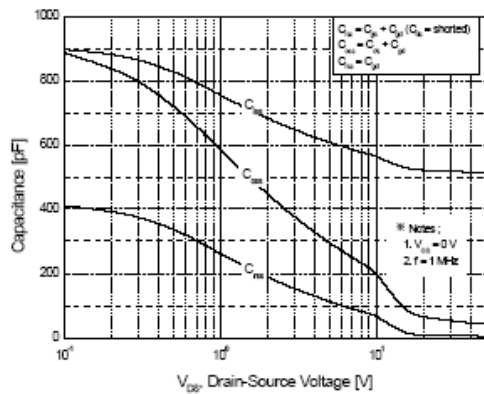

Figure 5. Capacitance Characteristics

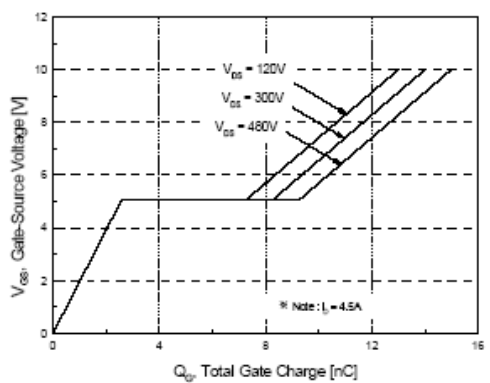

Figure 6. Gate Charge Characteristics

Typical Characteristics (Continued)

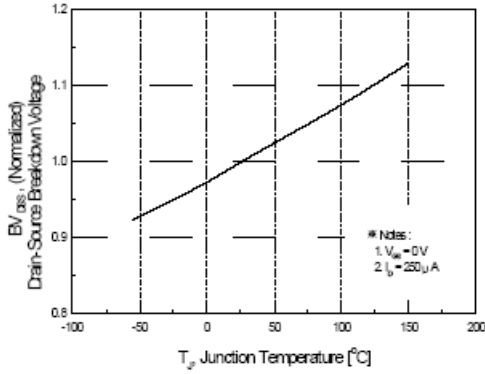

Figure 7. Breakdown Voltage Variation vs Temperature

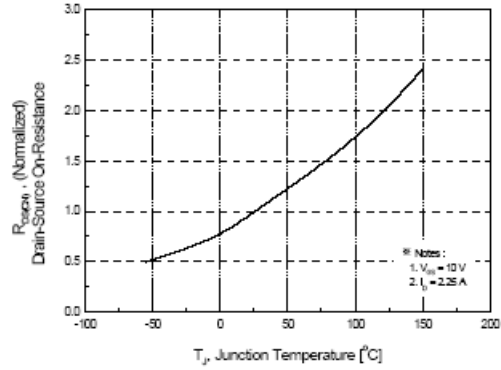

Figure 8. On-Resistance Variation vs Temperature

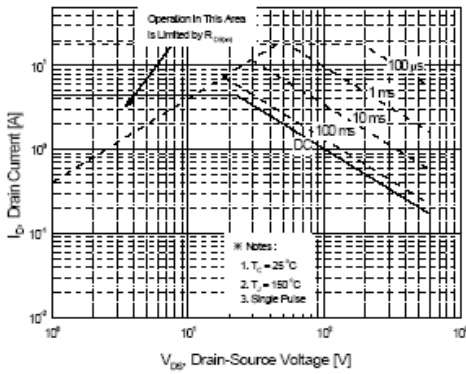

Figure 9-1. Maximum Safe Operating Area for TSP4N60M

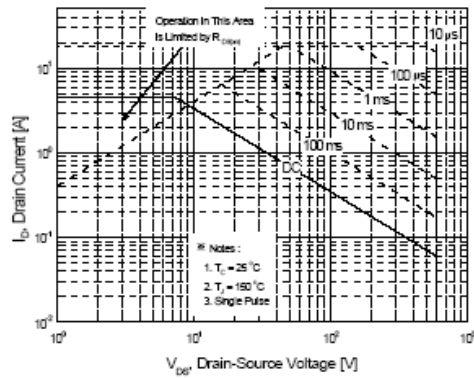

Figure 9-2. Maximum Safe Operating Area for TSF4N60M

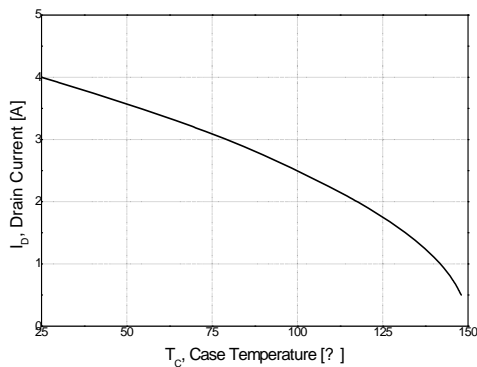

Figure 10. Maximum Drain Current vs Case Temperature

Typical Characteristics (Continued)

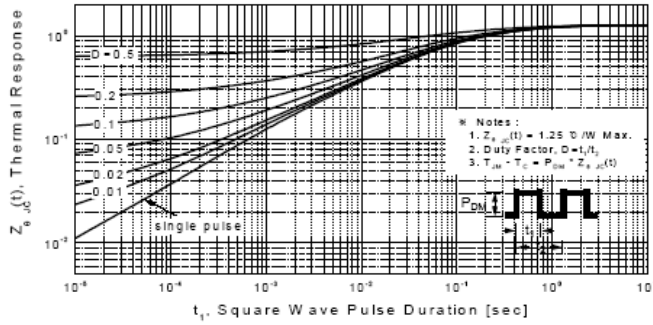

Figure 11-1. Transient Thermal Response Curve for TSP4N60M

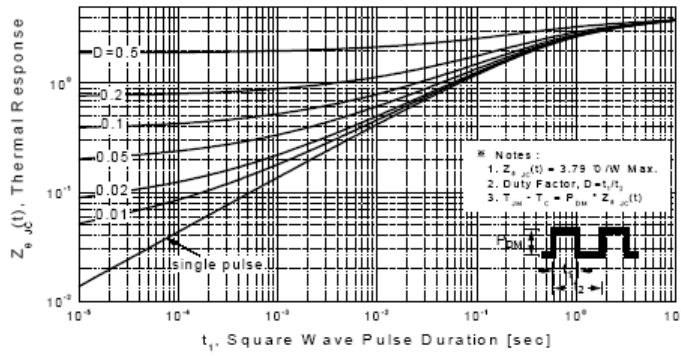
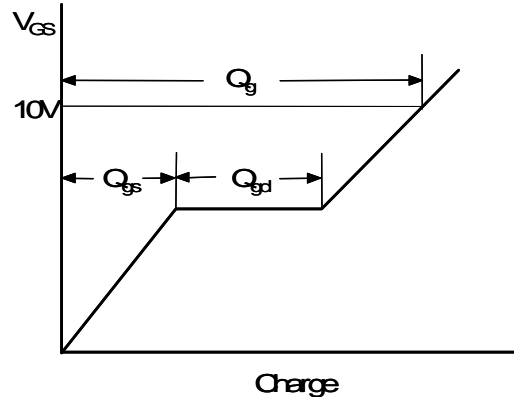
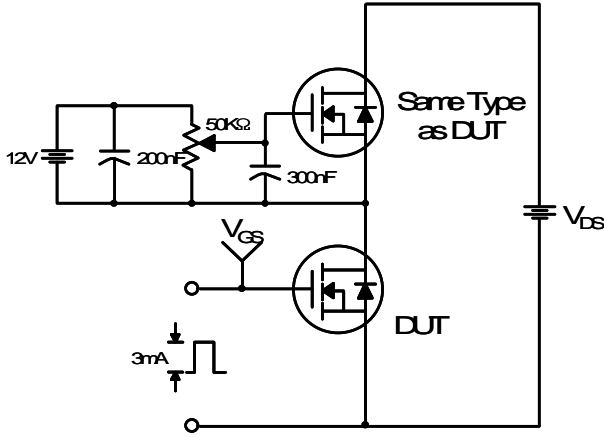
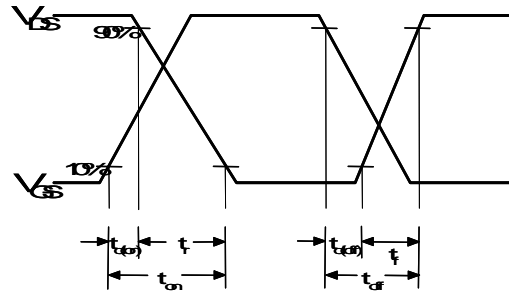
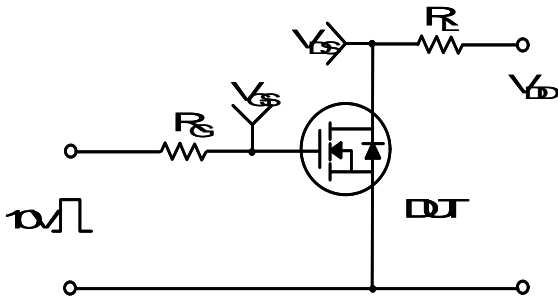

Figure 11-2. Transient Thermal Response Curve for TSF4N60M

Gate Charge Test Circuit & Waveform



Resistive Switching Test Circuit & Waveforms



Unclamped Inductive Switching Test Circuit & Waveforms

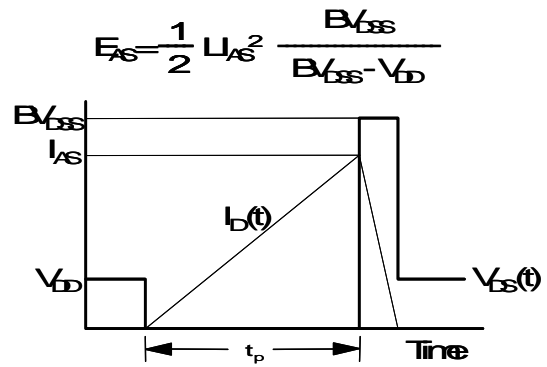
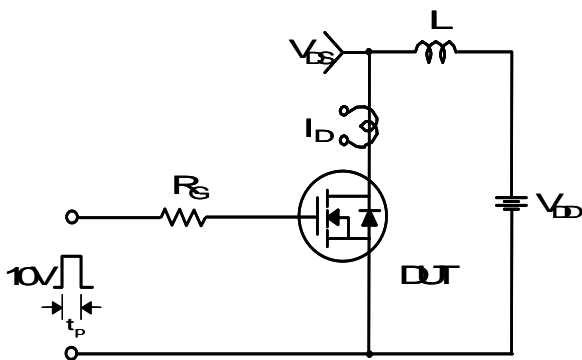

Peak Diode Recovery dv/dt Test Circuit & Waveforms

